

Logic Training Chair with Tablet Arm

Assembly Instructions

Logic Training Chair with Tablet Arm

Components List

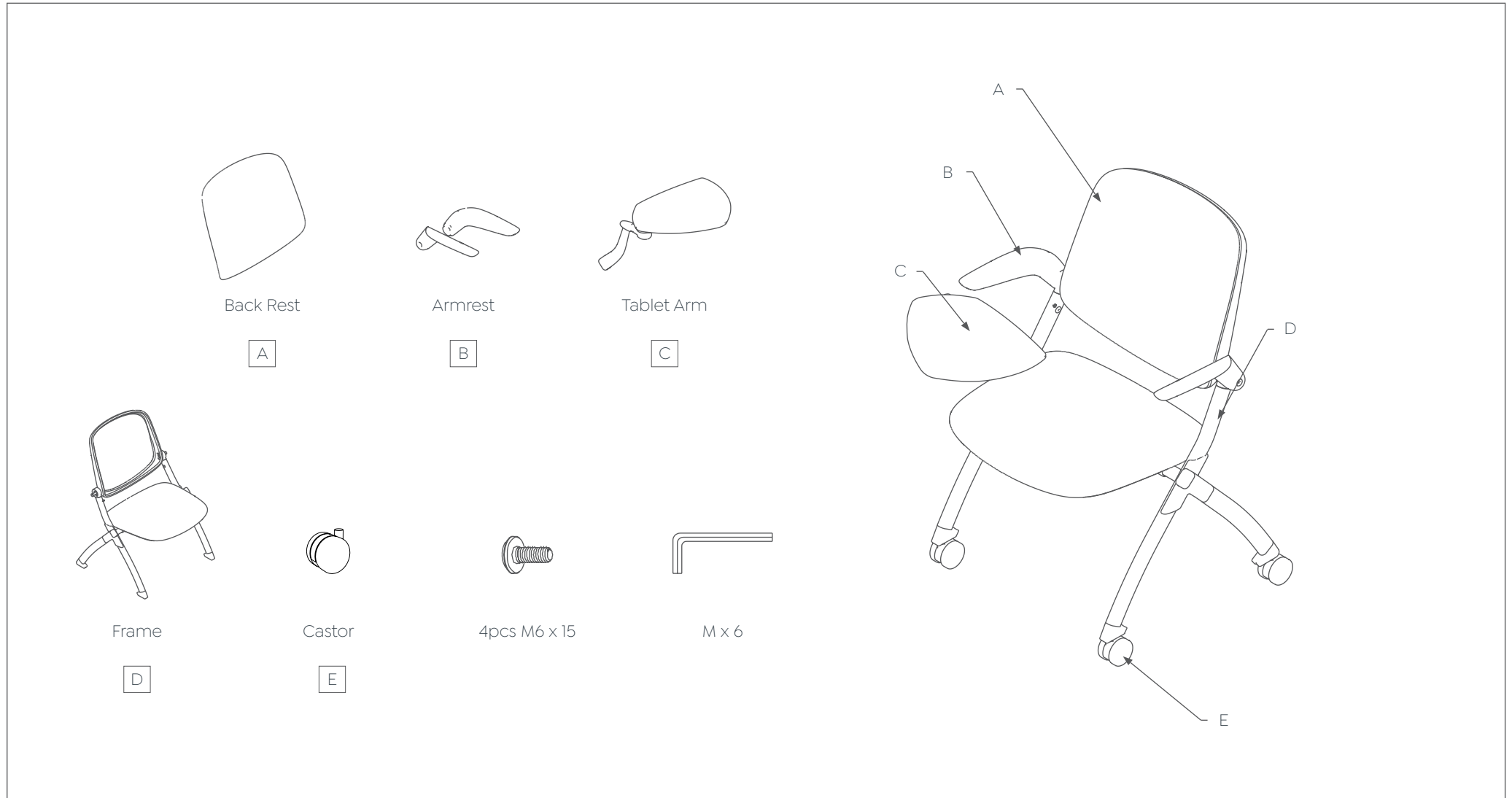

Logic Training Chair with Tablet Arm

Components List

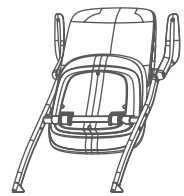

A x 1

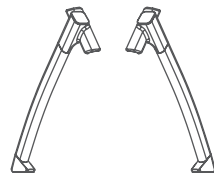

B x 2



C x 4



M6 x 15



M x 6

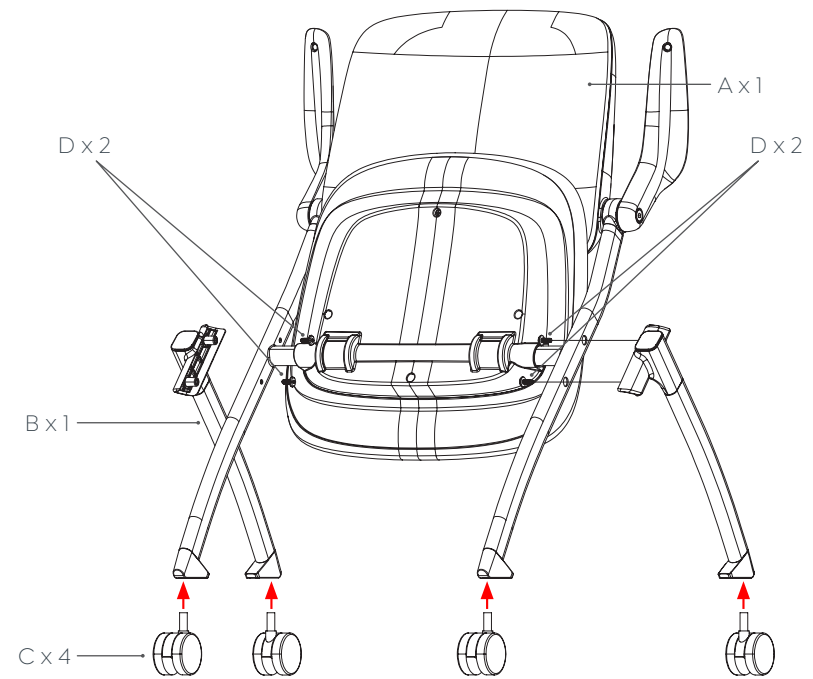

Logic Training Chair with Tablet Arm

Assembly Instructions

STEP 1:

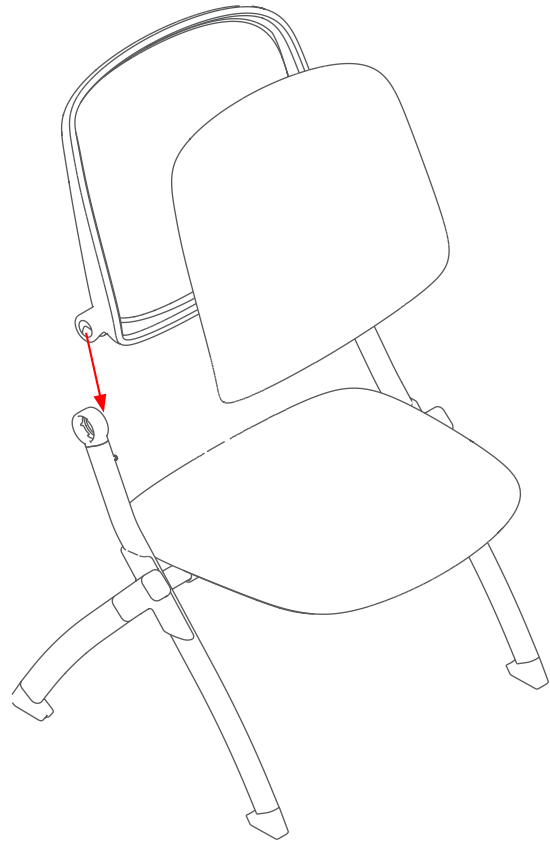

STEP 2:

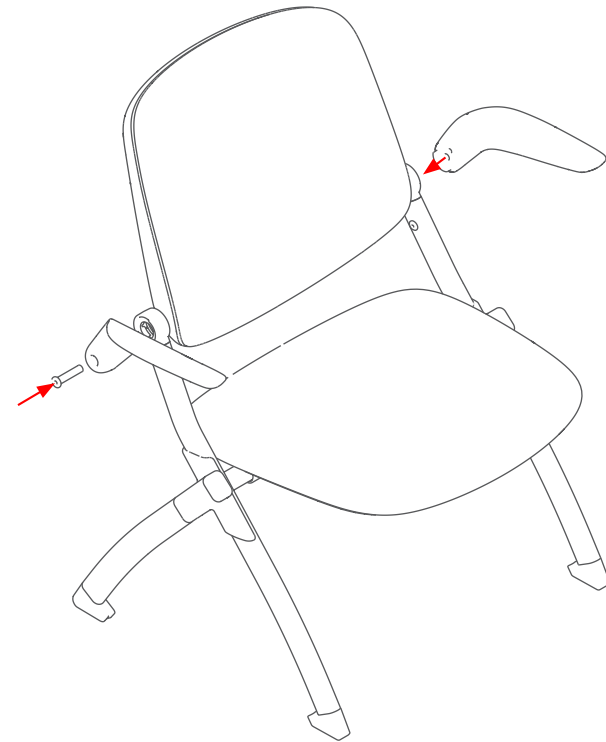

Logic Training Chair with Tablet Arm

Assembly Instructions

STEP 3:

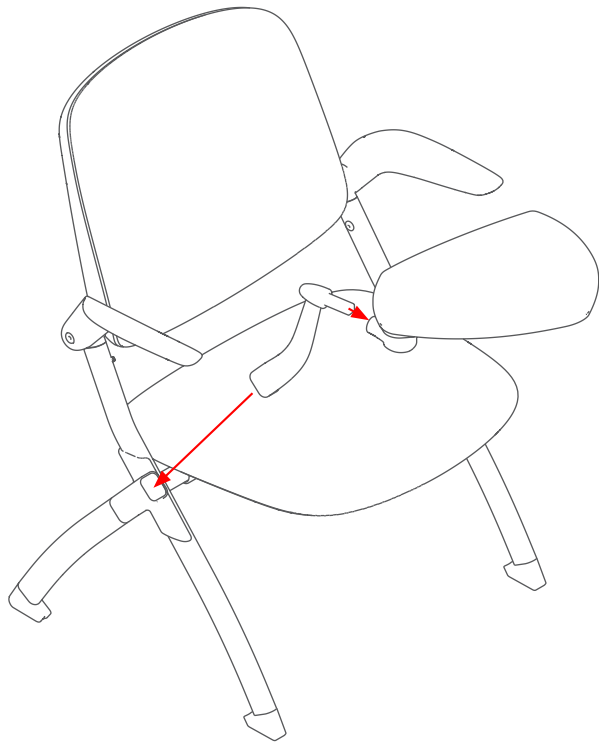

STEP 4:

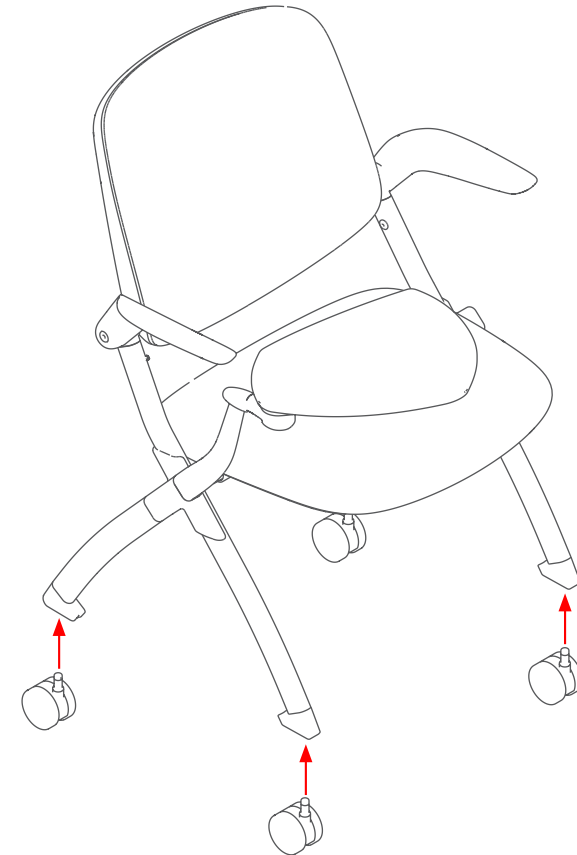

Logic Training Chair with Tablet Arm

Assembly Instructions

Complete:

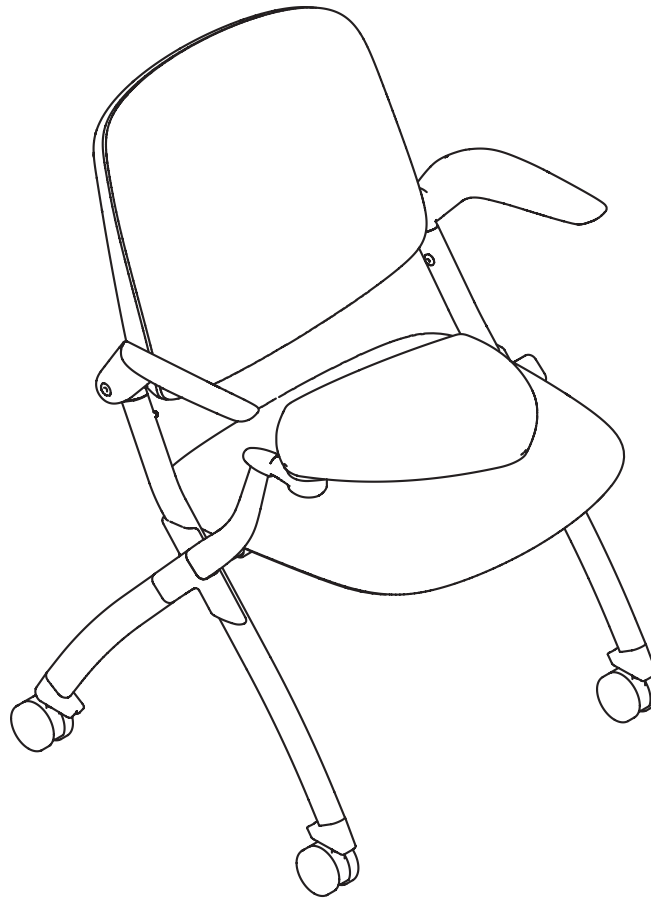



Sydney 02 8188 2732
Melbourne 03 9111 0315
Brisbane 07 3733 1923
Adelaide 08 7111 0810
Perth 08 9468 2707

info@olgoffice.com

myolg.online | olgoffice.com | officedesigner.net | motionoffice.com