

SpacePod.

Product Specifications



Innovative Thinking • Responsive Support • Open Communication

myolg.online

SpacePod.

When silence is golden and privacy is paramount, the SpacePod offers the perfect escape from the noisy office floor.

Insulated by layers of sheet metal, birch plywood, recycled acoustic foam and acoustic felt, stepping inside feels like walking into a professional recording booth. Not only are you shielded from outside noise, but the internal acoustic treatments provide for crystal-clear, echo-free audio quality on phone and video calls. Mid to high range soundwaves are damped by the acoustic felt while rounded floor and ceiling joinery helps address the build-up of low, bass sounds.

Available to use within hours of construction, the SpacePod includes a gas lift stool, tabletop, LED lighting, air-ventilation system, USB A/C ports and a 240V electrical power outlet.

Placed in the middle of an open plan office or tucked away next to the overbooked meeting rooms, the SpacePod is the best way to incorporate private spaces without breaking the budget.

Key Features

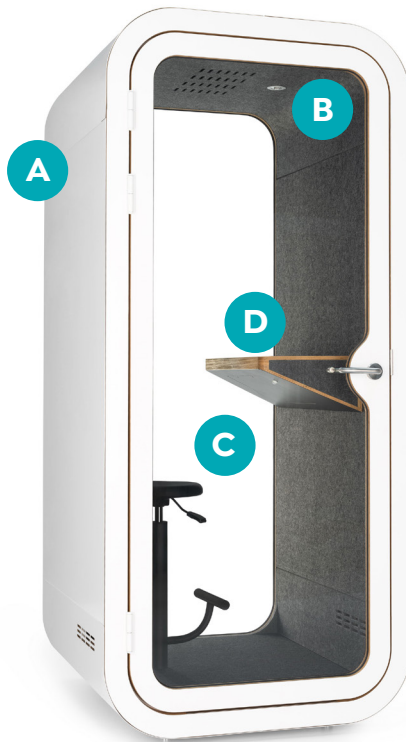

A. Solid Construction

Sheet metal, birch plywood, recycled acoustic foam and acoustic felt.

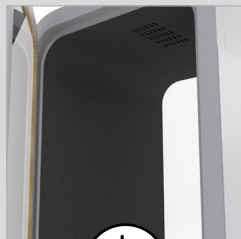

B. Noise Cancellation

Superior speech level reduction of 30.99 dB.



C. Glass Door & Rear

Sound control laminated glass door and rear wall.

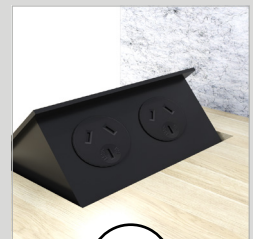

D. Power Options

240 volt power socket and USB charging.

SpacePod.

In Detail



Air Ventilation

More than 1m³.minute standard adjustable ventilation options.



Internal Lighting

LED lighting with brightness adjustment options.



Quality Materials

Sheet metal, birch plywood, recycled acoustic foam and acoustic felt.



Anti Static

Anti-static and stain resistant low loop pile carpet on interior floor.

Glass Door & Rear

Sound control laminated glass door and rear wall.

Noise Cancellation
Superior speech level reduction of 30.99 dB.

Anti-Static Materials

Anti-static and stain resistant low loop pile carpet on interior floor.

Internal Lighting

Adjustable LED lighting.

Air Ventilation

More than 1m³ per minute standard adjustable ventilation options.

Power Options

240 volt power socket and USB charging.

Solid Construction

Sheet metal, birch plywood, recycled acoustic foam and acoustic felt.



* Refer to page 5 for Ratings & Certifications details.

SpacePod.

Optional Upgrades



Single Spacepod with custom exterior colour



Single Spacepod with custom interior colour



Single Spacepod with custom seat upholstery colour

Dimension Specifications

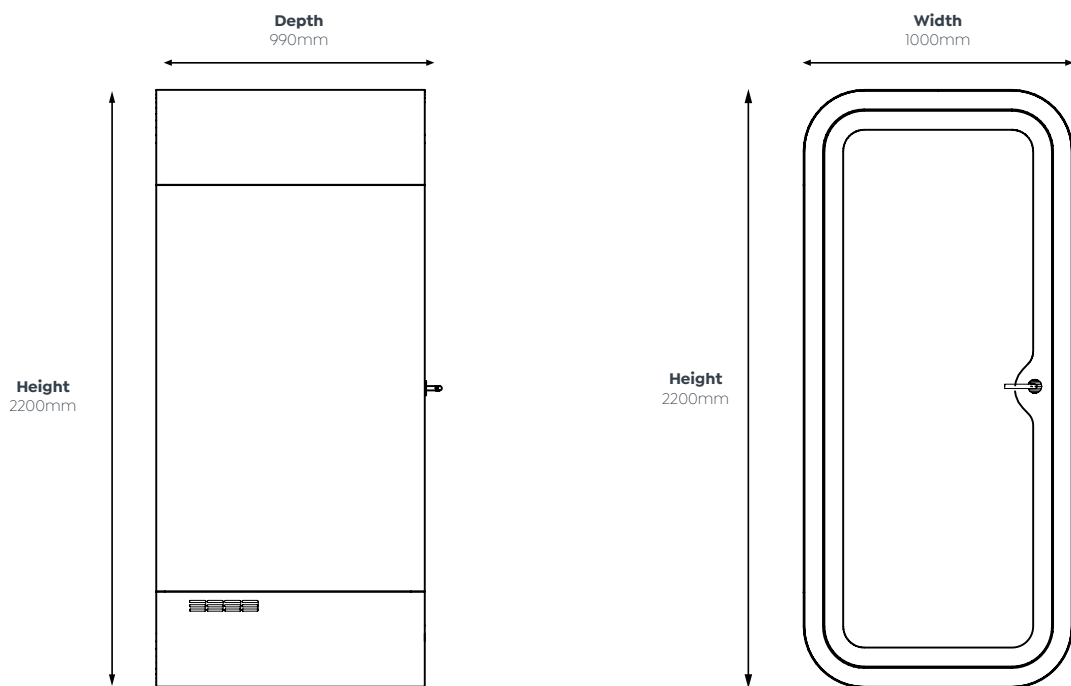

SpacePod.

2 User & 4 User Optional **Upgrades**



2 User Spacepod
with custom colour



4 User Spacepod
with custom colour

Dimension **Specifications**

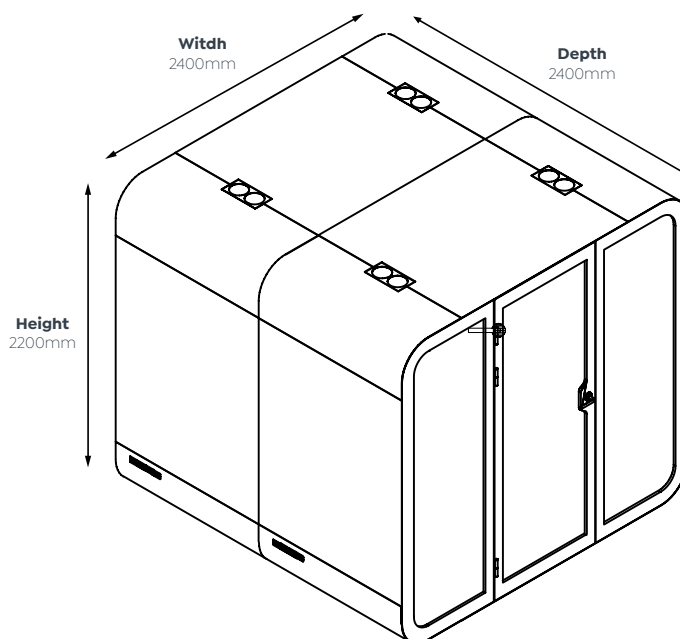
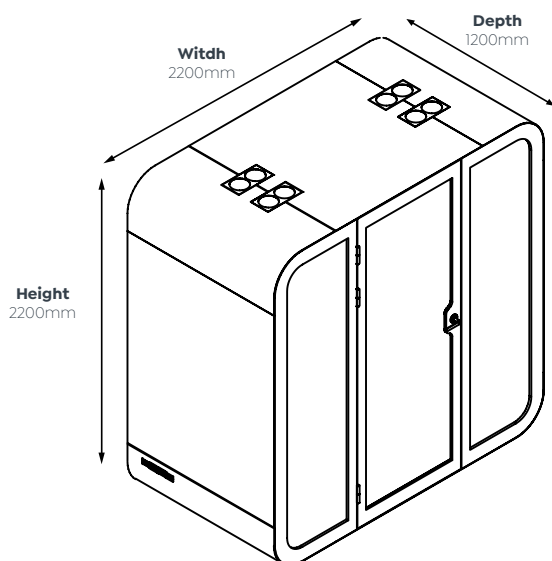

SpacePod.

Standard Colours - In Stock



Frame and table
-White HPL standard



Exterior- RAL 9016
White Standard

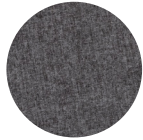

Sofa Upholstery
standard

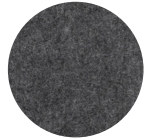

Interior PET felt
standard



Carpet
standard

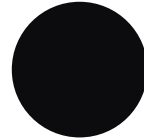

Exterior- RAL 9005
Black Standard

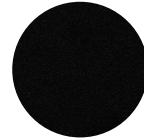

Frame and table
-Black HPL
standard

Colour Options - Exterior colour options



RAL 9016 White
Standard



RAL 7035
Light Grey



Khaki
Green



RAL 2012
Salmon Orange



RAL 3020
Traffic Red

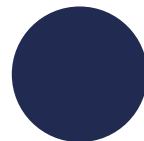

RAL 5013
Cobalt Blue

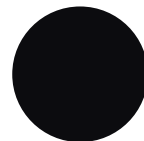

RAL 9005
Black Standard

Colour Options - Frame and table



Frame and table
-White HPL standard



F0927
Formica



F0803
Formica



F2962
Formica



F1238
Formica



F0806
Formica

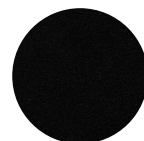

Frame and table
-Black HPL standard

Colour Options - Sofa Upholstery

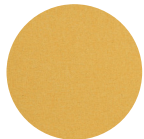

HE512-05



HE512-10



HE512-06



HE512-20

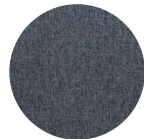

HE512-11

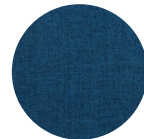

HE512-09



HE512-13

Colour Options - Interior - PET acoustic felt

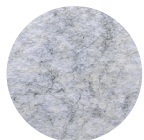

PC2033

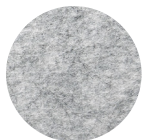

FG2125



814

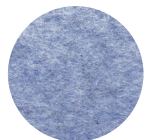

PP2028



FP2016

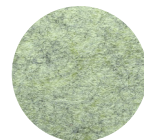

FPE2120

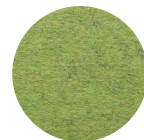

PG2039

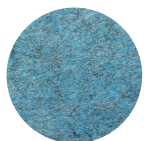

FB2021



PO2019

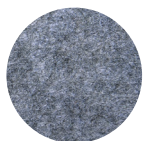

FG2032

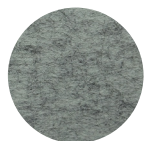

FE2121



FC2110



PC2022

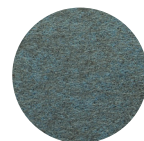

PB2037



PG2018

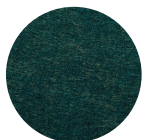

PB2025

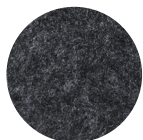

817

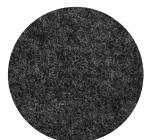

A028

Custom colours have lead time - contact an AcoustiQ representative for details

OLG's Ratings & Certifications.



10 Year Warranty

OLG Warranty promises the original purchaser that it will repair or replace with comparable product, at its option and free of charge (for material and components), any product, part or component which fails under normal use over the duration of the specified warranty term (taken from the date of purchase). Normal commercial usage is defined as the equivalent of a single shift, 40 hour work-week.



Weight Rating

All seating products have an OLG endorsed 120kg minimum weight rating. All OLG seating products are designed with reference to relevant international standards, including ANSI/BIFMA and AS/NZS. These standards stipulate strength & durability requirements and give the user confidence about the product's longevity. OLG's ISO certified factories use propriety test rigs to issue OLG's own weight ratings for chairs.



ISO 14001

ISO 14001 Certification is the international standard that specifies requirements for an effective Environmental Management System (EMS). It provides a framework that OLG as an organization can follow. At OLG we are using this framework as an approach to continuous improvement across all environmental aspects of our business.



ISO 9001

ISO 9001 Certification is the world's most widely recognized Quality Management System (QMS). At OLG its our guiding principle to meet the expectations and needs of our customers through quality management systems that continually monitor and manage quality across all operations to deliver consistent performance and service.



AS/NZS 4801

AS/NZS 4801 is the benchmark to assess Occupational Health & Safety Management systems for organisations. This standard contains vital information about meeting legal requirements and invaluable guidance on how to establish sustained improvement in health and safety performance in your business.



GECA Certification

GECA (The Good Environmental Choice Australia) Ecolabelling Program, operates a national third-party, independently verified ecolabel, in conformance with Environmental labels and declarations (ISO 14024), that can be applied to a wide range of products and services. This certification gives you an independent, reliable and convenient way to select OLG products and services that are certified by GECA to deliver better environmental outcomes. Anvil and Axis (available to GECA specification by special request). EkoSystem approved as EKO Brand.



AFRDI Certification

AFRDI Certification is a set of standards covering strength, durability, stability and safety (and ergonomics in the case of desks and workstations). This means that OLG are accountable for maintaining the quality of our products, submitting them for regular auditing to ensure they meet the highest standards for commercial use. Applies to: Urban Mesh (Level 6 – Severe Commercial), Modulus Flip Table (Level 3 – Severe Commercial, tested with 1500 x 750 top and Agile+ Single Sided Dual Motor Electric Desk).



BIFMA Certification

BIFMA Certification focuses on safety and performance standards developed by the BIFMA Engineering Committee. The standards provide manufacturers, specifiers, and users with a common basis for evaluating safety, durability, and the structural adequacy of the specified furniture, independent of construction materials. The standards define specific tests, laboratory equipment to be used, the conditions of test, and the minimum acceptance levels to be used in evaluating these products. Applies to: Balance Executive, Balance Task, Optic Chair, Adapta Chair, Game Chair 4 leg, Game Chair 4 leg with seat and back pads, Game Sled, Game Sled with seat and back pads, Agile+, Agile Electric 2-Column single motor, Motion Sync



Australian Trusted Trader

Australian Trusted Trader Certification is a standard that rewards companies showing compliant behaviour, secure supply chain with strong security practices, to enjoy a wide range of trade facilitation benefits. OLG have held this status since 2017.



FSC

FSC is the leading catalyst and defining force for improved forest management and market transformation, shifting the global forest trend toward sustainable use, conservation, restoration, and respect for all. Applies to: Plantation timber legs



GREENGUARD Certification

A GREENGUARD Certification ensures that a product has met some of the world's most rigorous and comprehensive standards for low emissions of volatile organic compounds (VOCs) into indoor air. GREENGUARD Gold Certification offers certification criteria that considers safety factors to account for sensitive individuals (such as children and the elderly), and ensures that a product is acceptable for use in environments such as schools and healthcare facilities.

SpacePod.

Cheat Sheet Quick Guide

Standard Features

Exterior

Powder coated steel

Glass (door & rear)

Sound control laminated glass

Frame and table

Laminate on birch plywood with varnish trim

Solid walls, roof and floor

A sandwich element of sheet metal, birch plywood, recycled acoustic foam and acoustic felt. An anti-static and stain resistant low loop pile carpet for interior floor.

Measurements

Exterior (height, width, depth)

2200 × 1000 × 990mm

Interior (height, width, depth)

2000 × 800 × 898mm

Door (height, width)

2046 × 846mm

Table (width, depth, height)

650 × 300 × 160mm

Electric sockets are integrated on the table

Air Ventilation

Air Ventilation Ventilation rate:

More than 1m³/minute standard
Available Higher ventilation options

Power consumption

Power consumption standard

3.24W while in use

0.75W standby power consumption

Input:

110-240VAC, 10A, 50/60Hz

Outlets

Regular table:

Power socket + USB-A

Output values

Output VAC (power socket):

100-240 VAC, 8 A, 50-60 Hz

Output USB charging:

USB Type A socket (Type C option)

Maximum combined output 18 W

Acoustic performance

For Speech Level Reduction (DSA), and Noise Isolation Class (NIC), third party test reports are available on request

Packaging and transportation

Net weight (kg): 336

Gross weight (kg): 428

Packaging size: 2270×830×1130mm

Upgrade Options

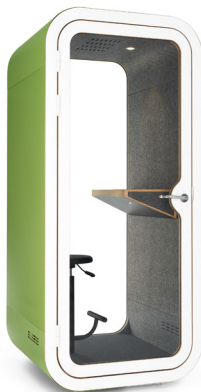

Single Spacepod with custom exterior colour



Single Spacepod with custom interior colour



Single Spacepod with custom frame and table colour



Single Spacepod with custom seat upholstery colour

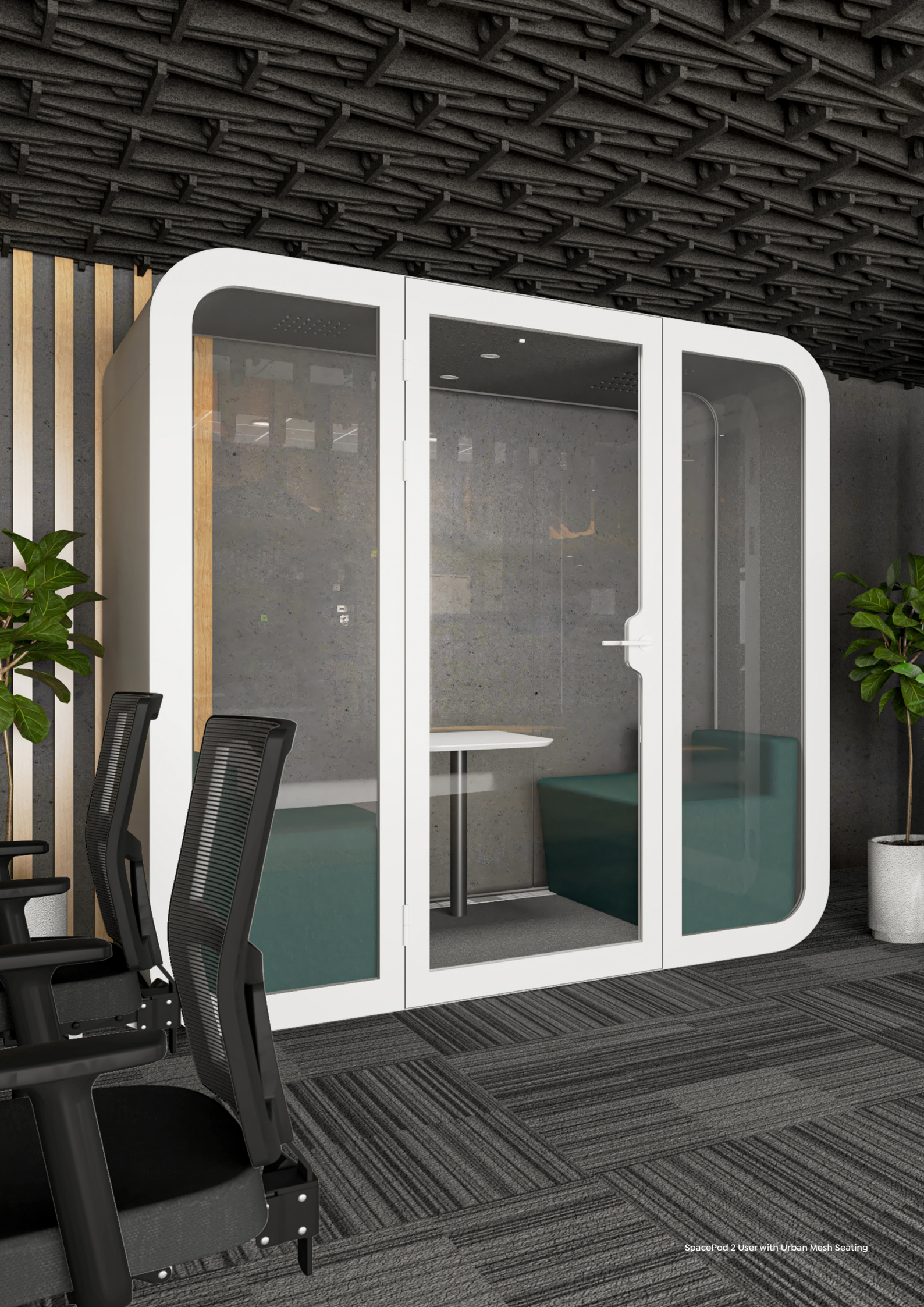

SpacePod 2 User with Urban Mesh Seating



SpacePod Single User, MotionOffice Otto, Plantation Desking with Radius18 Screens and Axis Mobile Caddy

Additional Options.

Desking



QuickStand Desk
Height Adjustable
Single Sided Desk



Agile Fixed
Single Sided Desk



Agile Fixed
90° Workspace



Agile Fixed
Desk with Return



Agile Fixed
2 User 90° Workspace



Agile Winder
Height Adjustable
2 User Double Sided Desk



Agile Winder
Height Adjustable
Single Sided Desk



Agile Electric 2 Column
Height Adjustable
Single Sided Desk



Agile Electric 2 Column
Height Adjustable
90° Workspace



Agile Electric 2 Column
Height Adjustable
2 User 90° Workspace



Agile+ Electric 3 Column
Height Adjustable
Single Sided Desk



Agile+ Electric 3 Column
Height Adjustable
90° Workspace



Agile+ Electric 3 Column
Height Adjustable
120° Workspace



Agile+ Electric 3 Column
Height Adjustable
2 User Double Sided Desk



Agile+ Electric 3 Column
Height Adjustable
Triple 120° Workstation



Agile+ Round Legs 3C
Electric Height Adjustable
Single Sided Desk



Agile+ Round Legs 3C
Electric Height Adjustable
Single Sided Desk



Agile+ Round Legs 3C
Electric Height Adjustable
Single Sided Desk



Agile+ Round Legs 3C
Electric Height Adjustable
Single Sided Desk



Agile+ Round Legs 3C
Electric Height Adjustable
Triple 120° Workstation



Anvil
Single Sided Desk
with Studio50 Screen



Anvil
Single Sided
90° Workspace



Anvil
2 User Double Sided
90° Workspace



Anvil
2 User Single Sided Desk
with Studio50 Screen



Axis
Single Sided Desk
with Modesty



Axis
Single Sided Desk
with Return



Axis
2 User Single Sided Desk
with Studio50 Screen



EkoSystem
Single Sided Desk



EkoSystem
Single Sided Desk with Return



EkoSystem
90° Workstation



How can we be of help?

02 8188 2732

info@olgoffice.com

myolg.online

olgoffice.com

officedesigner.net

motionoffice.com

officefitoutcalculator.com.au

myolgpricelist.online

acoustiq.com.au