

Knox Locker (50-LK4D)

Assembly Instructions

Knox Locker (50-LK4D)

Components List

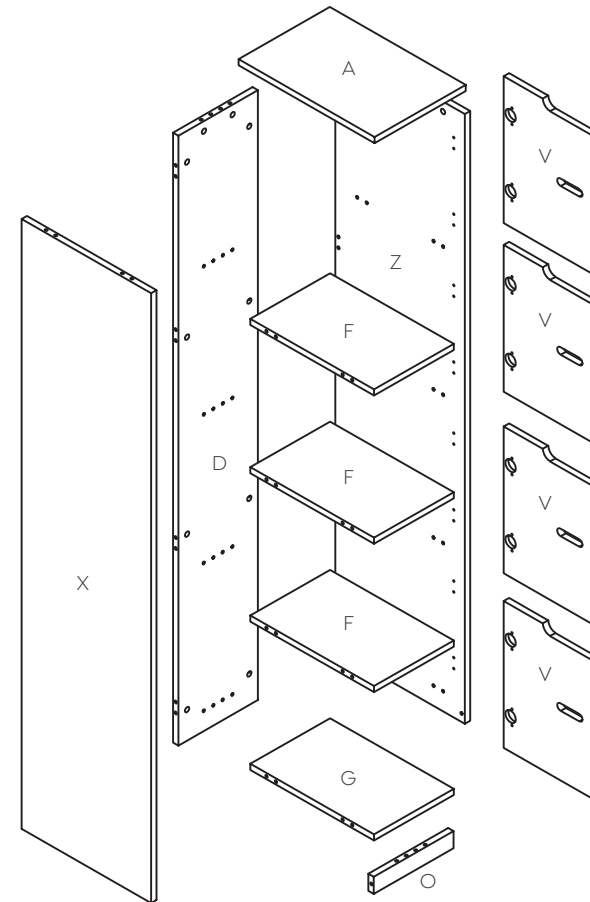
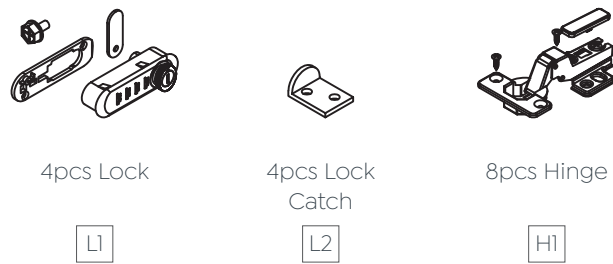
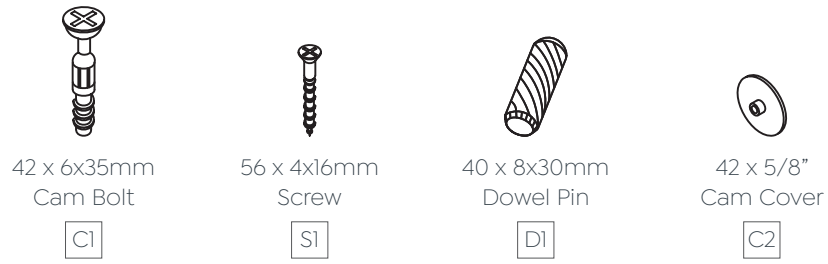

STEP 1:

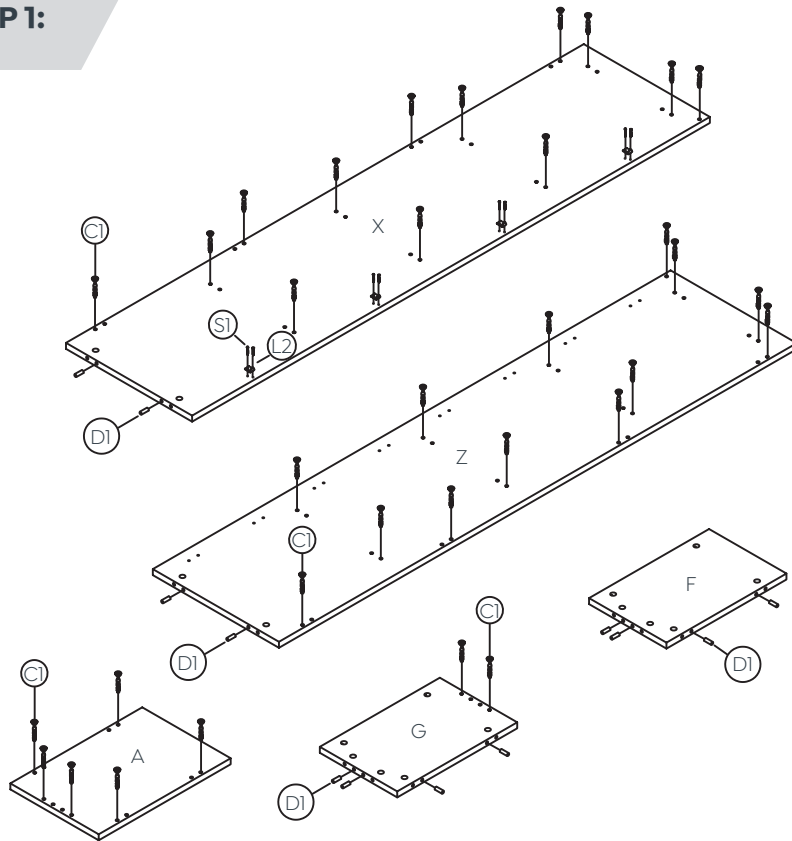

Preparation for panels X, Z, F*3, A, G.

1. Insert cam bolts C1 into panels X, Z, A and G as illustrated above.
2. Insert dowel pins D1 into panels F, X, Z and G as illustrated above.
3. Fix lock catch L2 to panel X with screw S1 as illustrated above.

STEP 2:

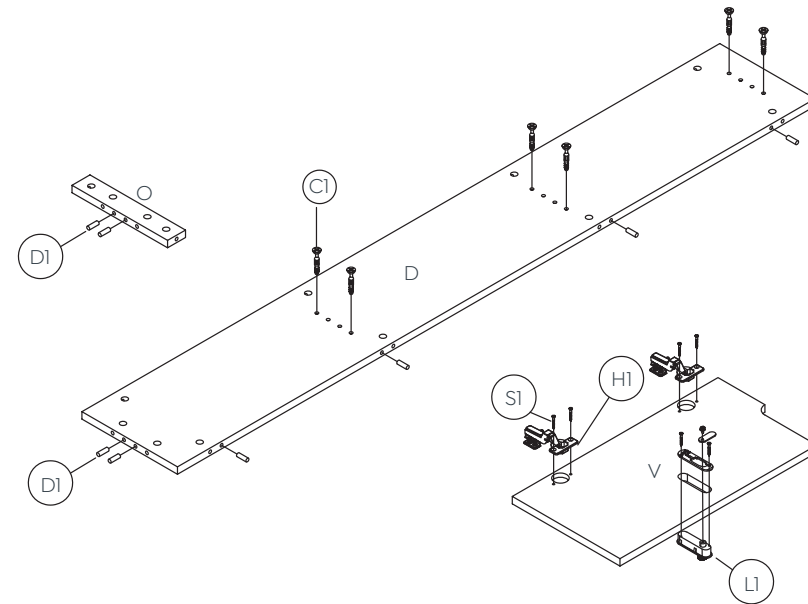

Preparation for panels V*4, O, D.

1. Insert cam bolts C1 into panels D as illustrated above.
2. Insert dowel pins D1 into panels D and O as illustrated above.
3. Fix lock L1 to panel V with screw 3.5x20 as illustrated above.
4. Fix hinge bodies H1 to panel V with screws S1 as illustrated above.

Knox Locker (50-LK4D)

Assembly Instructions

STEP 3:

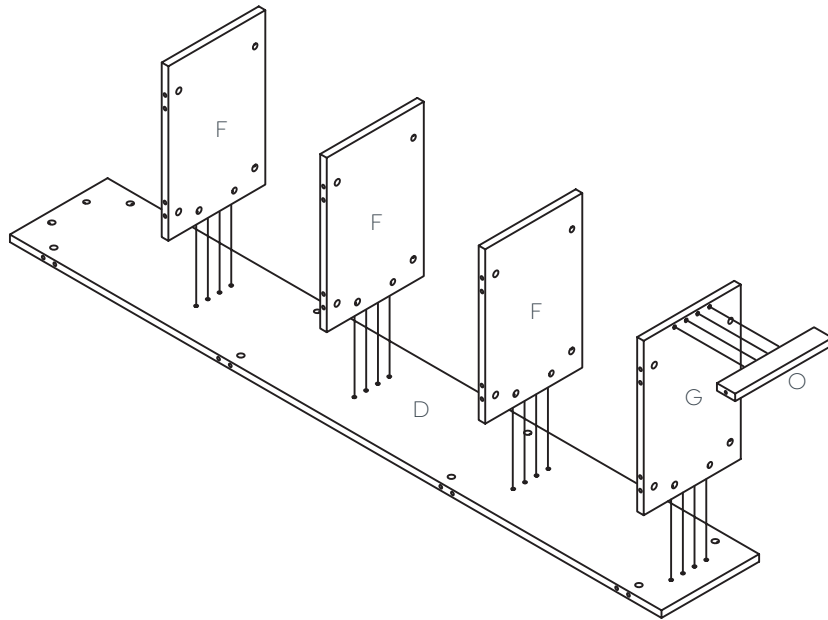

Panels F, G and D assembly.

1. Insert cam bolts C1 on panel O into cams on panels G and tighten in a clockwise direction as illustrated above.
2. Insert cam bolts C1 on panel F and G into cams on panel D and tighten in a clockwise direction as illustrated above.

STEP 4:

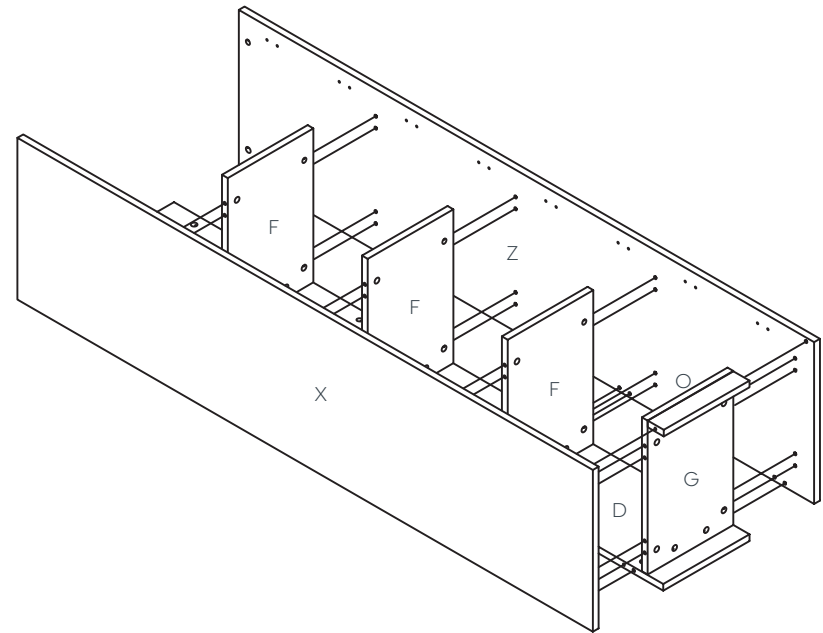

Panels X and Z assembly.

1. Insert cam bolts C1 on panel X and Z into cams on panels O, G, F and D and tighten in a clockwise direction as illustrated above.

STEP 5:

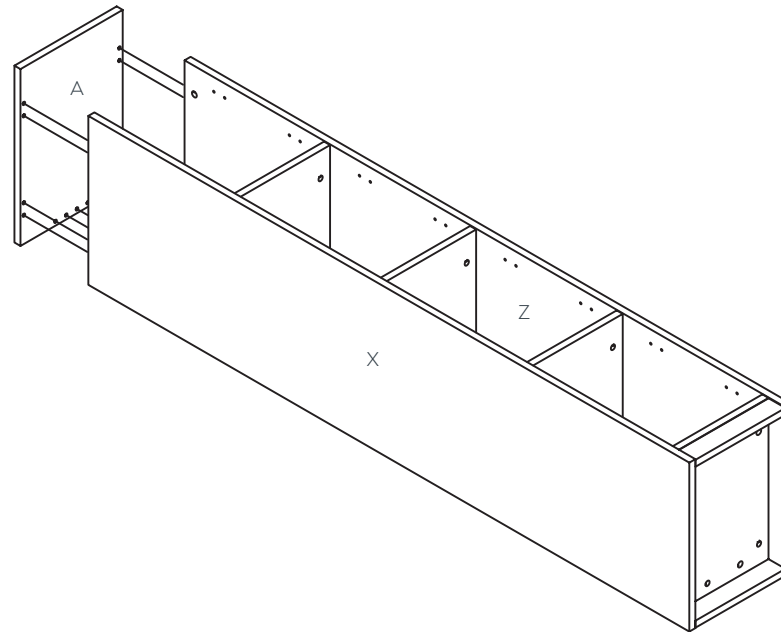

Panel A assembly.

1. Insert cam bolts C1 on panel A into cams on panels X, Z and D and tighten in a clockwise direction as illustrated above.

Knox Locker (50-LK4D)

Assembly Instructions

STEP 6:

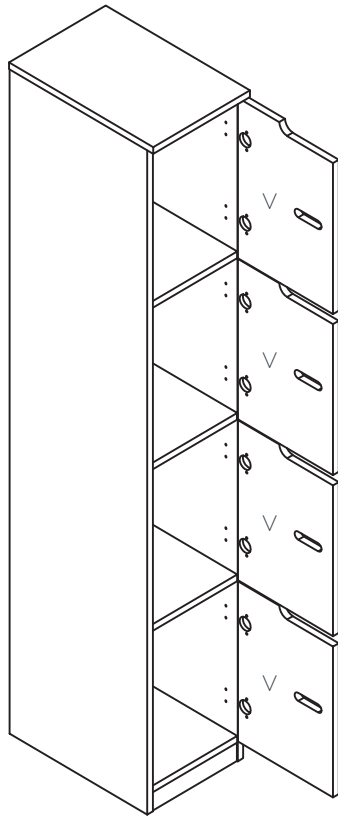

Door Panel V allocate with Hinge H1 assembly

Hinge assembly details as below:

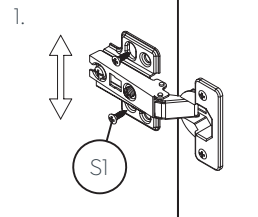

Fix the screws S1 into the predrilled hole shown above, and then adjust the door panel upward and downward to the right location.

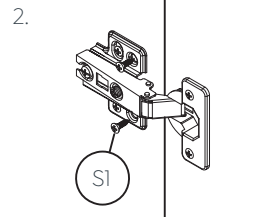

Fix the rest 2 pcs screws S1 to the panel to consolidate the hinge shown above.

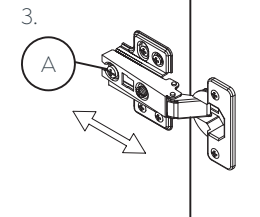

Loosen the screw A to adjust the forward and backward of the door panel to the right location, and then tighten the screw A.

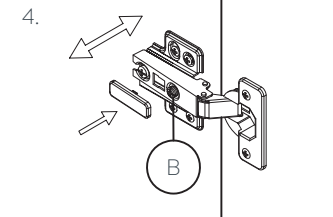

Loosenthe screw B to adjust the leftward and rightward of the door panel to the right location, and finally cover the hinge with the cap.

Complete:

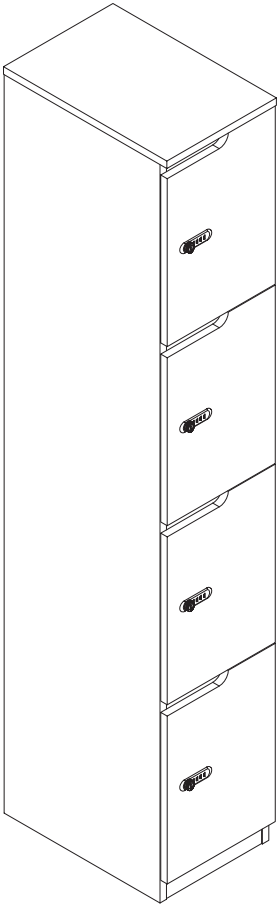



Sydney 02 8188 2732

Melbourne 03 9111 0315

Brisbane 07 3733 1923

Adelaide 08 7111 0810

Perth 08 9468 2707

info@olgoffice.com

myolg.online | olgoffice.com | officedesigner.net | motionoffice.com