

The OLG logo is positioned in the top right corner, consisting of the letters 'OLG' in a white, sans-serif font inside a dark red rectangular box. The background of the entire image is a series of overlapping, parallel diagonal bands in various colors including red, orange, yellow, green, and blue, creating a sense of depth and movement.

edge25

by OLG

Light, seamless, refined.



Edge25 Screens
Purpose-built for modern Australian workspaces.

edge25

by OLG

Light, seamless, refined

A minimalist solution for modern workspaces, Edge25 Screens embody refined simplicity and intelligent design. Engineered for seamless integration, the system features sleek, slimline connectors crafted from powder-coated aluminium, enhancing both durability and aesthetics.

Designed for efficiency, Edge25 is 70% lighter than traditional screens and utilises 50% fewer components, allowing for faster installation and reduced environmental impact. Choose from a curated palette of 10 colourways in Edge25 fabric (55k Martindale rub rating) or opt for the luxurious Sunday fabric in 60 colours, with an industry-leading 110k Martindale rating.

Fully pinnable and available in custom sizes, Edge25 offers a tailored solution for dynamic work environments. Made in Australia, backed by a 10-year warranty, and designed to elevate acoustic and visual privacy, this is a screen system that works as hard as you do.



Defining Features.

Minimalistic Design

Premium Styling with fine aluminium edging and pinnable core.

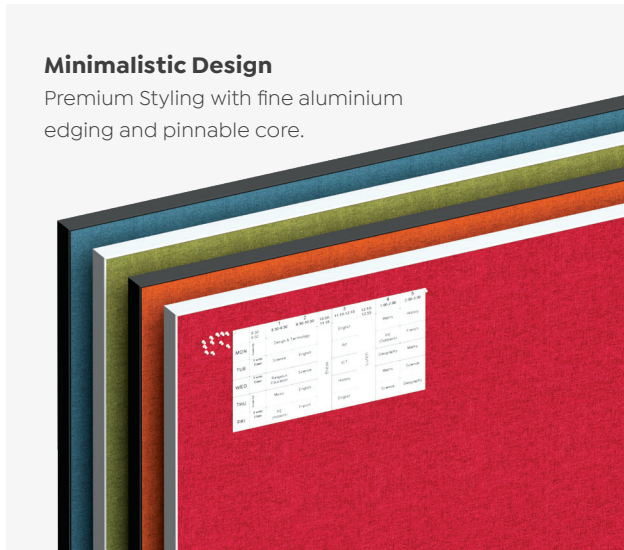

Custom Sizing

Sizing from 400 – 2400 wide and 400 – 2400 high.

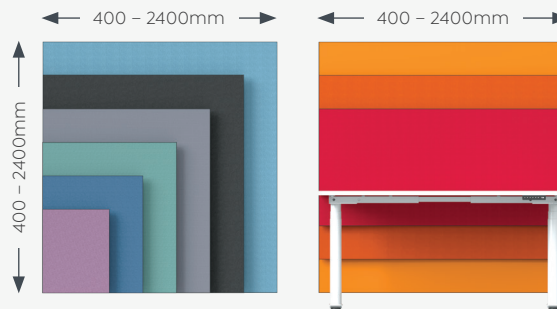

Endless Colour Combinations

10 x Edge25 colour and 30 x Premium Sunday fabric colour combinations. 1,000's of other colour options.

See page 10 for all colour options.



70% less install time

Just panels and joiners, that's it!

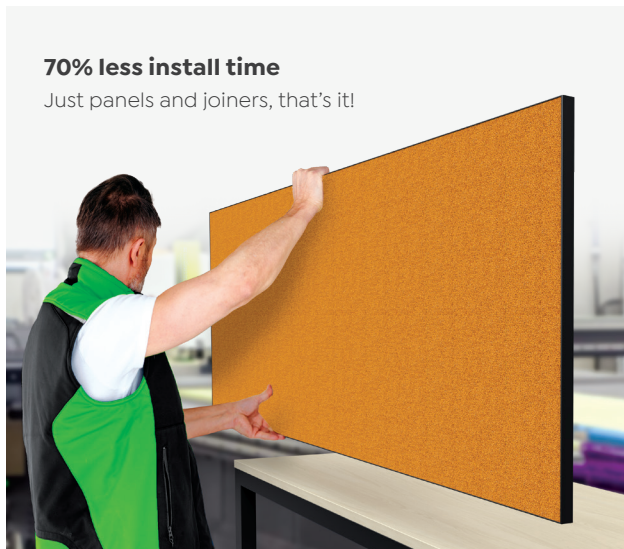

Unique Joining

Minimalistic joining system, quick to install and strong connections.



Lightweight & Proudly Australian Made

70% lighter with 50% fewer components.

Proudly made in Australia backed by a 10-year warranty.



Configurations.

Below are the recommended configurations for various desk setups.



Class Height Adjustable Double Desks for 4 Users with Edge25 Desk Screens

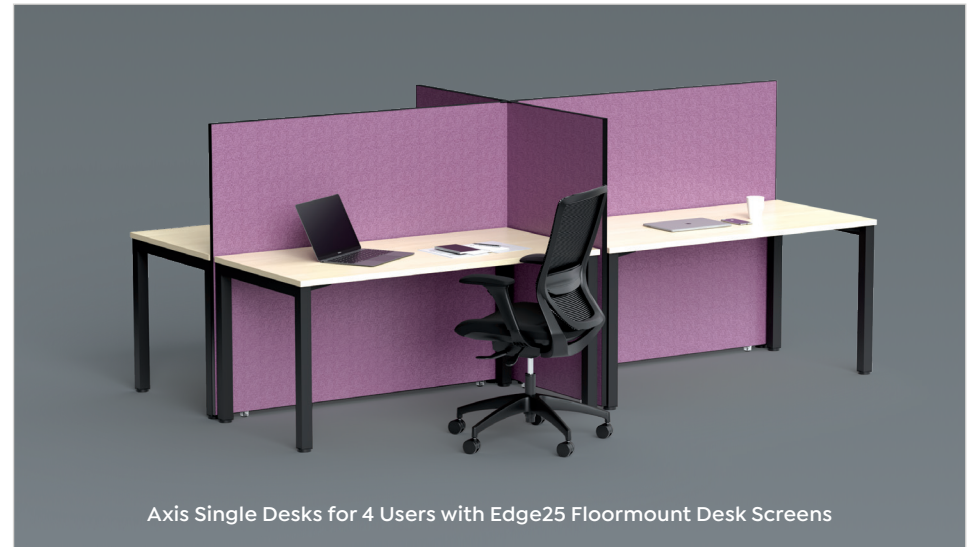

Axis Single Desks for 4 Users with Edge25 Floormount Desk Screens

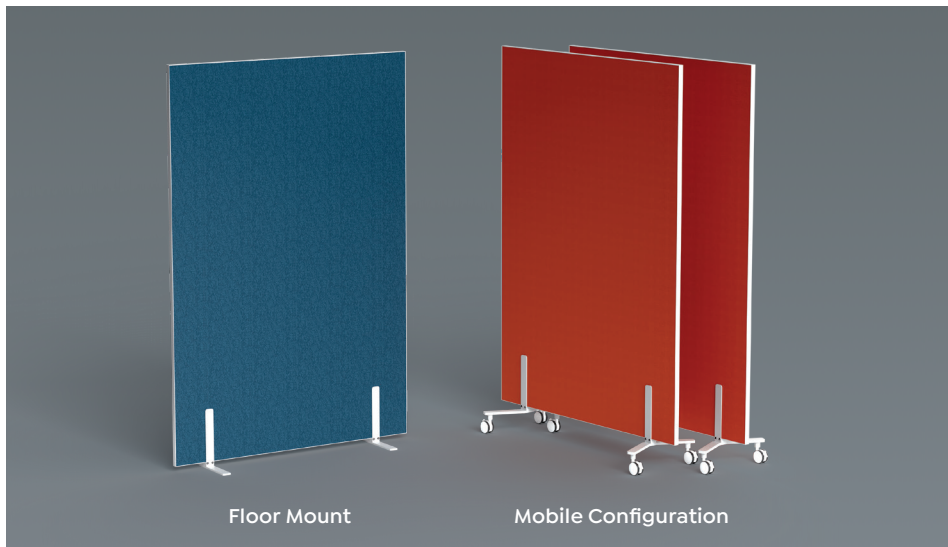

Floor Mount

Mobile Configuration



Anvil 4-User Double Sided Desk with Edge25 Spine Screens with Returns

Fixed Desk Frames.

How to configure your Edge25 Screens for fixed desks

- 1 Choose your worktop size**
Available in 1800, 1600, 1500 & 1200mm wide with 750mm depth



- 2 Choose your screen size**
Sizing from 400 – 2400 wide and 400 – 2400 high

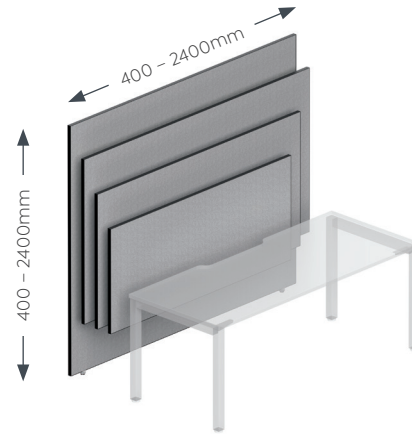

- 3 Choose your screen colour and frame colour**
Refer to page 10 for all screen frame and fabric colours

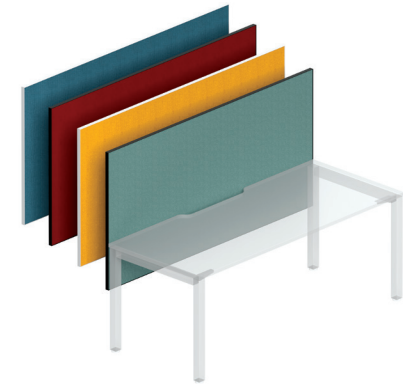

- 4 Choose your screen joiners**
Refer to page 11 for all joiner options

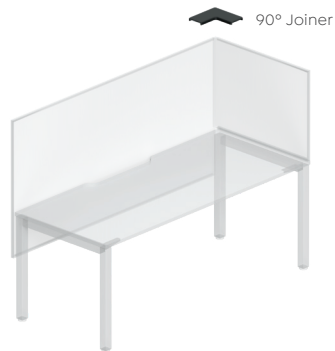

- 5 Choose your depth of end-leg**
Available: Klas, Aglie, Axis, Anvil, Flare, & Plantation

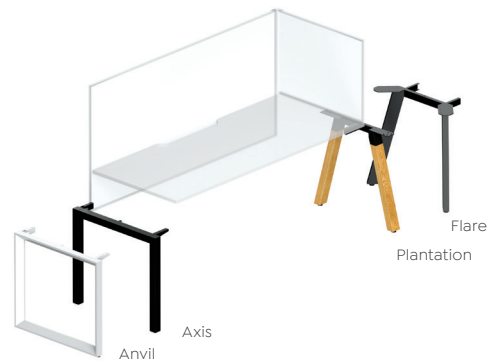

- 6 Choose the appropriate bracket**
Refer to page 11 for all bracket options

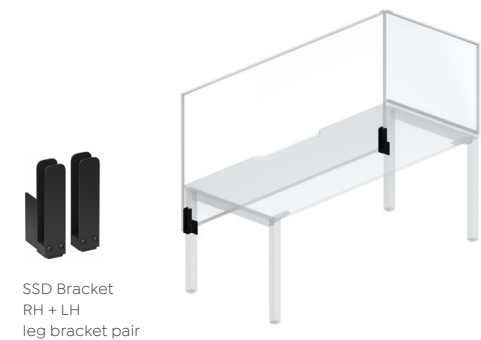

Height Adjustable Desk Frames.

How to configure your Edge25 Screens for height adjustable desks

- 1 Choose your worktop size**
Available in 1800, 1600, 1500 & 1200mm wide with 750mm depth



- 2 Choose your screen Size**
Sizing from 400 – 2400 wide and 400 – 2400 high

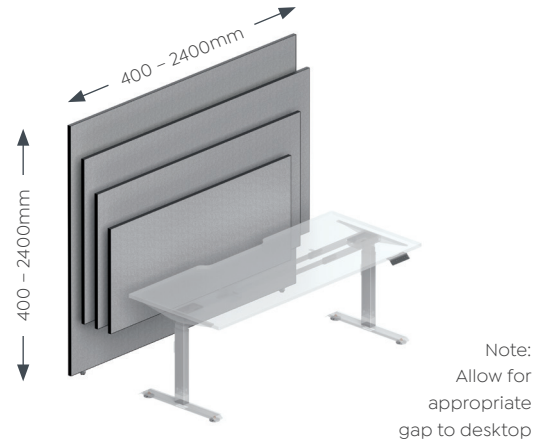

- 3 Choose your screen colour and frame colour**
Refer to page 10 for all screen frame and fabric colours



- 4 Choose your screen joiners**
Refer to page 11 for all joiner options



- 5 Choose your electric desk leg type**
Available: Klass, AgileMotion+, (DSD or SSD)

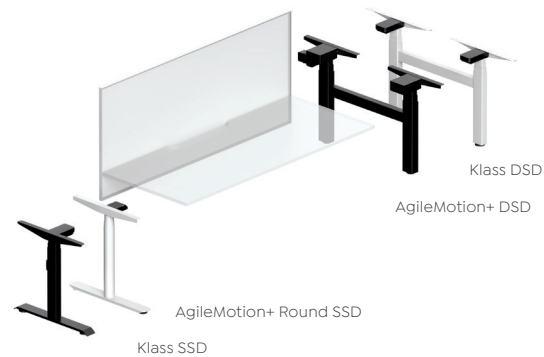

- 6 Choose the appropriate bracket**
Refer to page 11 for all bracket options



Components.

A configuration example along with its components.

1 Edge25 Spine Screens

2 Edge25 Wing Screens

3 3-Way Screen Joiner



4 4-Way Screen Joiner



5 Adjustable Feet





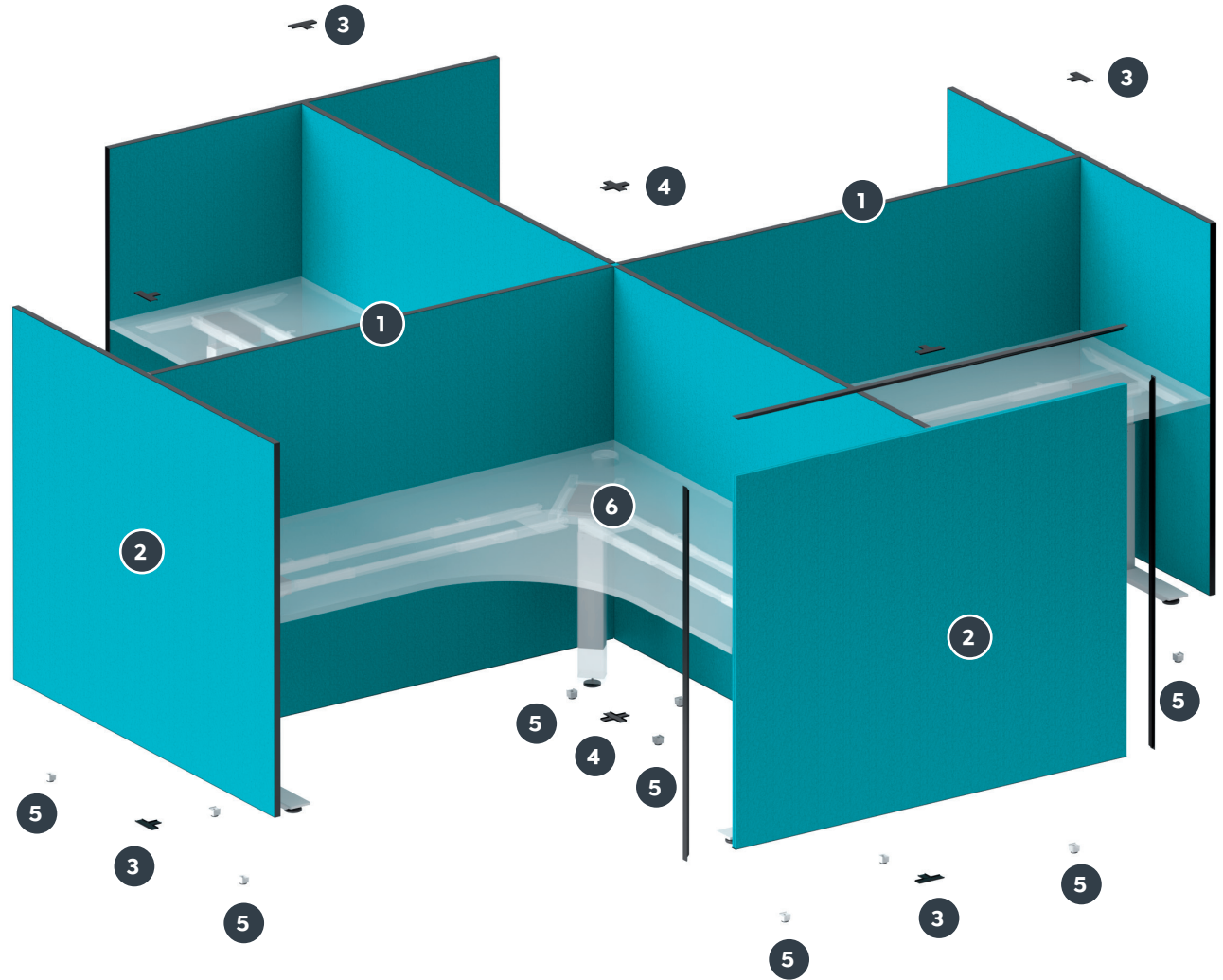











6 AgileMotion+ 90° Workstation Desk



Brackets.

All brackets are available in a black or white powder-coated finish.

Floor Mount Screens	Agile Mounting Hardware	Klass Mounting Hardware	Axis/Anvil Mounting Hardware	Worktop Mounting Hardware
 <p>Static Feet Rectangle</p>	 <p>SSD Bracket Rectangle</p>	 <p>SSD Bracket Suit 600-700mm width desktop</p>	 <p>SSD Bracket RH + LH leg bracket pair</p>	 <p>Under Desk Desktop Bracket</p>
 <p>Mobile Feet Movable</p>	 <p>SSD Bracket Round</p>	 <p>SSD Bracket Suit 750-900mm width desktop</p>	 <p>DSD Bracket</p>	
 <p>Floor Mount Feet Adjustable Feet</p>	 <p>DSD Bracket Plate</p>	 <p>DSD Bracket Plate</p>		
	 <p>DSD Return Bracket</p>	 <p>DSD Return Bracket</p>		

Joiners.

All joiners are available in a black or white powder-coated finish.

 <p>Straight Joiner</p>	 <p>90° Joiner</p>	 <p>3-way Joiner</p>	 <p>4-way Joiner</p>
---	--	---	--

Colours.

Endless Colour Combination

Choose from 10 Edge25 combinations, 30 Premium Sunday fabric colours, and thousands of other custom options.

Sunday Fabric



Breathe Fabrics

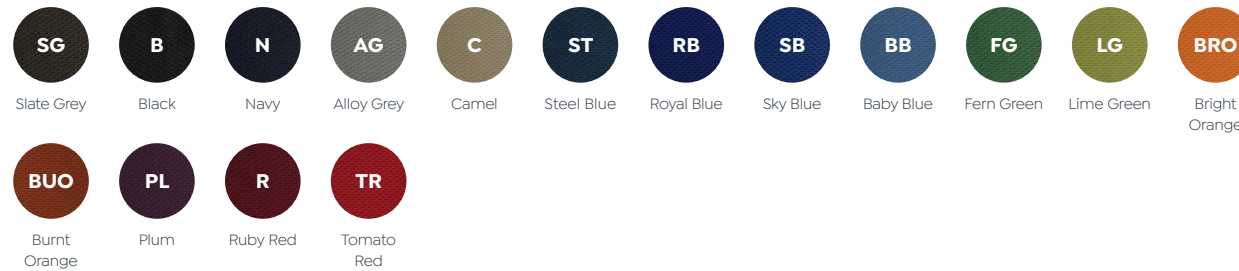

Splice Colours



Edge25 Fabrics

Black Frame

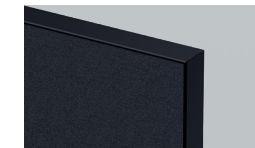

Graphite #20-25

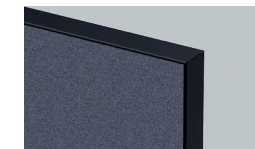

Smoke Grey #25-03

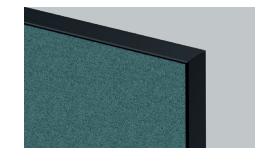

Sage Green #25-14

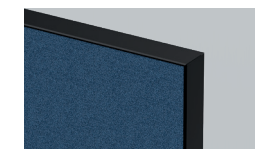

Misty Blue #25-07

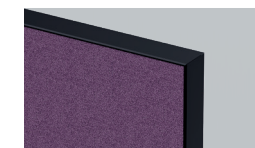

Maroon #25-06

White Frame

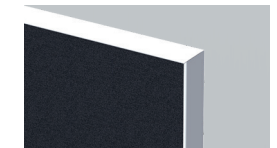

Graphite #20-25

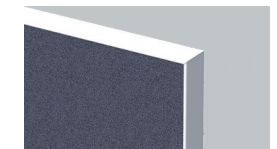

Smoke Grey #25-03

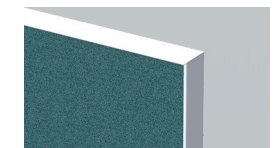

Sage Green #25-14

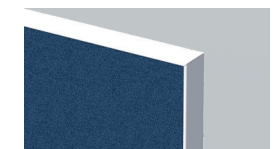

Misty Blue #25-07

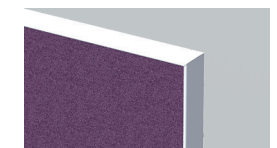

Maroon #25-06



Ready to elevate your next Project?

Visit our website to reach out to
your Customer Partnership

The OLG logo is positioned in the top left corner. It consists of the letters 'OLG' in a bold, white, sans-serif font. The background of the entire page is a vibrant, multi-colored geometric pattern of overlapping, parallel lines that create a sense of depth and movement, transitioning from teal and green on the left to yellow and orange in the center, and finally to a solid red on the right.

edge25

by OLG



02 8188 2732
info@olgoffice.com

in OLG-Office
myolg.online | olgoffice.com